

## METAL AND MELAMINE PEDESTALS

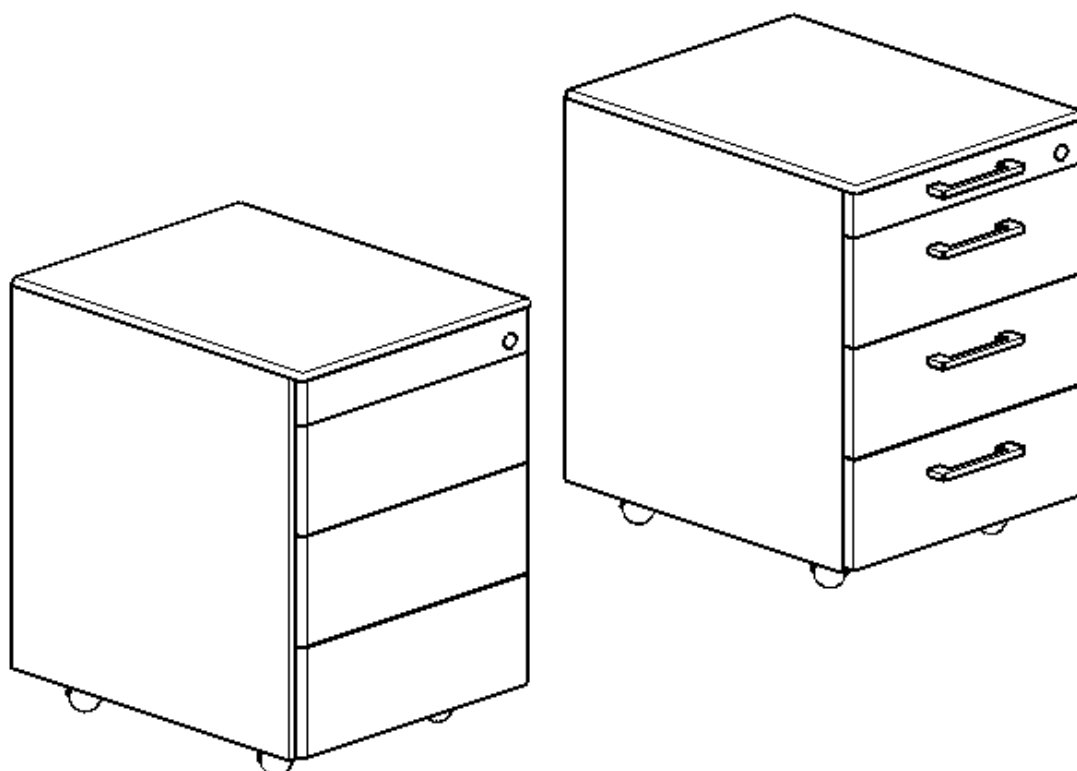

## METAL PEDESTAL ON WHEELS

Including a single-bloc steel plate shell, suitably folded, and welded. It is equipped with four spinning wheels of Ø50 at its base. The pedestal is available with three A6 drawers, or with one A4 size drawer and one A6 size drawer for holding suspended folders; the useful space inside the A6 drawer is cm 33x46x10.5. The drawer shell is designed to hold transversal separating elements. Drawers slide on simple thick steel printed plate extractable tracks, equipped with nylon coated metal ball bearings. The pedestal is equipped with a Yale type locker with a double foldable key for simultaneously locking all the drawers and with an anti-overturning safety device. Inside the drawer, it is possible to place some accessories, like a plastic stationery holder (for the A6 size drawer), a horizontal separating element (for the A6 size drawer) and folders of L.33 and H.25 cm (for the A4 size drawer). The structure is coated with epoxy polyester powders polymerized in an oven at 200°C, the drawer shell is painted in black.

## METAL PEDESTAL ON WHEELS WITH MELAMINE FRONTAL DRAWERS

Including a single bloc steel plate shell, suitably folded, and welded. The upper metal top finish has a radial front edge. On its base, it is equipped with four spinning wheels of Ø60. The pedestal is available with three A6 drawers, or with two A4 size drawers and one A6 size drawer; in both cases, a little stationary drawer with a plastic holder inside can be added. The drawer shell is designed to hold transversal separating elements. Drawer fronts are made of melamine of thickness 18 mm, each one of which is equipped with a silver plastic bow hand le. Drawers slide on simple thick steel printed plate extractable tracks, equipped with nylon coated metal ball bearings. The pedestal is equipped with a Yale type locker with a double foldable key for simultaneously locking all the drawers and with an anti-overturning safety device. Inside the drawer, it is possible to place some accessories, like a plastic stationery holder (for the A6 size drawer), a horizontal separating element (for the A6 size drawer) and folders of L.33 and H.25 cm (for the A4 size drawer). The structure is coated with epoxy polyester powders polymerized in an oven at 200°C.

## “MINI” METAL PEDESTAL ON WHEELS

Including a single-bloc steel plate shell, suitably folded and welded. It is equipped with four spinning wheels of Ø50 at its base. The pedestal has three A4 size drawers, with a useful space inside each drawer of cm 24x46x10.5. The drawer shell (painted in black) is designed in order to hold transversal separating elements. Drawers slide on simple thick steel printed plate extractable tracks, equipped with nylon coated metal ball bearings. There are two alternative versions of this pedestal, namely with metal drawer fronts or melamine drawer fronts, of thickness 18 mm and with ABS edge. The pedestal is equipped with a Yale type locker with a double foldable key for simultaneously locking all the drawers and with an anti-overturning.

## MELAMINE PEDESTAL ON WHEELS

Made up of a grey or white melamine shell of thickness 18 mm; all the components (base, top, sides and back) are connected together. The pedestal has three A6 size drawers; drawers are silver colour, whereas melamine drawer fronts of thickness 18 mm are connected with the drawers themselves by means of paint. Drawers slide on simple extractable tracks, equipped with nylon coated metal ball bearings. Each drawer is equipped with a silver plastic bow-shaped handle. It is equipped with four spinning wheels of Ø50 at its base. The pedestal is equipped with a Yale type locker for simultaneously locking all the drawers and a foldable key for anti -accident purposes.

---

## TYPES

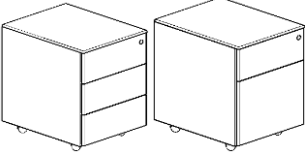
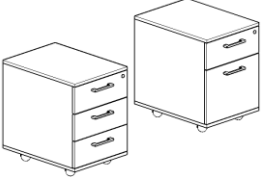
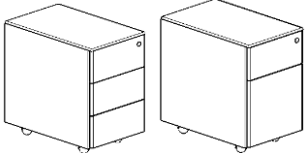
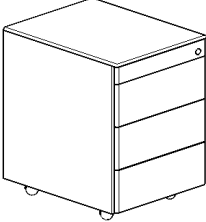
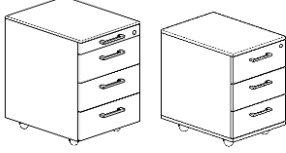
	<p>METAL PEDESTAL ON WHEELS – cm 42 x 54 x 54</p>	<p>3 DRAWERS  2 DRAWERS</p>	<p>MT3C  MT2C</p>
	<p>MELAMINE PEDESTAL ON WHEELS WITH WHITE OR GREY FRAME – cm 42 x 56 x 58</p>	<p>3 DRAWERS  2 DRAWERS</p>	<p>VZ3C  VZ2C</p>
	<p>MINI METAL PEDESTAL ON WHEELS – cm 33 x 54 x 54</p>	<p>3 DRAWERS  2 DRAWERS</p>	<p>MTCC3C  MTCC2C</p>
	<p>METAL PEDESTAL 3 DRAWERS + STATIONERY DRAWER ON WHEELS – cm 42 x 54 x 60</p>	<p>3 + 1 DRAWERS</p>	<p>MT3CCS</p>
	<p>METAL PEDESTAL ON WHEELS WITH MELAMINE FRONTAL DRAWERS</p>	<p>3 + 1 DRAWERS cm 42 x 54 x 60  3 DRAWERS cm 42 x 54 x 60</p>	<p>MT3CCSM  MT3CM</p>

## FINSHINGS

### METAL STRUCTURES



V01  
BIANCO  
WHITE  
BLANC

RAL 9016



V73  
ARGENTO  
SILVER  
ARGENT

RAL 9006



V98  
NERO  
BLACK  
NOIR

RAL 9011

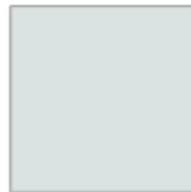

V48  
GHIACCIO  
ICE  
GLACE

RAL 7035

### MELAMINE STRUCTURES



T63  
BIANCO SYSTEM  
WHITE SYSTEM  
BLANC SYSTEM



T62  
GRIGIO CENERE  
ASH GREY  
GRIS CENDRE

### MELAMINE FRONTAL PANELS



T01  
BIANCO  
WHITE  
BLANC



T62  
GRIGIO CENERE  
ASH GREY  
GRIS CENDRE



T03  
PANNA  
CREAM  
CRÈME



T07  
FAGGIO  
BEECH  
HETRE



T09  
NERO  
BLACK  
NOIR



T32  
ROVERE CHIARO  
LIGHT OAK  
CHENE CLAIR



T40  
NOCE CANALETTO  
WALNUT  
NOYER



T42  
ROVERE SCURO  
DARK OAK  
CHENE NOIR



T48  
BIANCO VENATO  
VEINED WHITE  
BLANC VEINE



T60  
EUCALIPTO  
EUCALYPTUS